



# 1700V Dual Silicon Carbide Power Module

## GE17042BCA3

$V_{DS}$ : 1700 V  $I_{DS}$ : 425 A

Superior performance for high power, high frequency applications needing best-in-class power density



## Features

- Highly reliable GE SiC MOSFET devices
- Low  $R_{DS(ON)}$  (3.75 m $\Omega$ ) (device only)
- Low stray inductance (1 nH)
- Ultra-low switching losses over entire operating range
- GE Power Overlay wire-bondless technology
- Body diode with minimal reverse recovery
- Integrated temperature sensing
- AlSiC Baseplate and Si<sub>3</sub>N<sub>4</sub> AMB Substrate

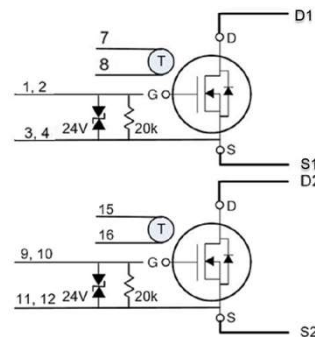

### MOSFET DC Characteristics @ $T_J = 25^\circ\text{C}$ (unless otherwise specified)

| Symbols        | Parameters                        | Min. | Typ.   | Max.    | Unit             | Test Conditions                                  | Notes      |
|----------------|-----------------------------------|------|--------|---------|------------------|--|------------|
| $I_{DS}$       | Continuous Drain Current          |      |        | 425     |                  | $V_{GS} = 20\text{ V}, T_c = 25^\circ\text{C}$   | Per Switch |
|                |                                   |      |        | 300     | A                | $V_{GS} = 20\text{ V}, T_c = 100^\circ\text{C}$  |            |
|                |                                   |      |        | 245     |                  | $V_{GS} = 20\text{ V}, T_c = 125^\circ\text{C}$  |            |
| $I_{DS,pulse}$ | Pulsed Drain Current              |      |        | 850     | A                | $T_c = 25^\circ\text{C}, t_p = 1\text{ ms}$      |            |
| $V_{DSmax}$    | Drain - Source Breakdown Voltage  | 1700 |        |         | V                | $V_{GS} = 0\text{ V}, I_{DS} = 100\ \mu\text{A}$ |            |
| $V_{GSmax}$    | Maximum Gate - Source Voltage     |      |        | -15/+23 | V                | $V_{DS} = 0\text{ V}$                            |            |
| $V_{GSop}$     | Recommended Gate - Source Voltage |      | -5/+20 |         | V                |  |            |
| $T_{Jmax}$     | Junction Temperature              |      |        | 175     | $^\circ\text{C}$ |  |            |
| $T_c$          | Case Temperature Range            | -55  |        | 150     | $^\circ\text{C}$ |  |            |
| $T_{STG}$      | Storage Temperature Range         | -55  |        | 150     | $^\circ\text{C}$ |  |            |
| $P_D$          | Power Dissipation                 |      |        | 1250    | W                | $T_c = 25^\circ\text{C}$                         |            |



(Continued) **MOSFET DC Characteristics @  $T_J = 25^\circ\text{C}$**  (unless otherwise specified)

| Symbols      | Parameters                        | Min. | Typ.         | Max.         | Unit       | Test Conditions  | Notes      |
|--------------|-----------------------------------|------|--------------|--------------|------------|--|------------|
| $I_{DS}$     | Continuous Drain Current          |      |              | 425          | A          | $V_{GS} = 20\text{ V}, T_c = 25^\circ\text{C}$   | Per Switch |
| $V_{GS(th)}$ | Gate Threshold Voltage            | 2.5  | 2.9          | 4.5          | V          | $V_{GS} = V_{DS}, I_{DS} = 160\text{ mA}$  |            |
| $I_{DSS}$    | Drain Leakage Current             |      |              | 0.10<br>1.6  | mA         | $V_{DS} = 1700\text{ V}, V_{GS} = 0\text{ V}, T_J = 25^\circ\text{C}$<br>$T_J = 175^\circ\text{C}$ |            |
| $I_{GSS}$    | Gate-Source Leakage Current       |      |              | 160          | nA         | $V_{GS} = -15/+23\text{ V}$  |            |
| $R_{DS(on)}$ | On State Resistance (Device Only) |      | 3.75<br>6.70 | 4.45<br>8.25 | m $\Omega$ | $V_{GS} = 20\text{ V}, I_{DS} = 425\text{ A}, T_J = 25^\circ\text{C}$<br>$T_J = 175^\circ\text{C}$ | Per Switch |
| $R_{G(int)}$ | Gate-Source Series Resistance     |      | 1.42         |              | $\Omega$   | $V_{GS} = 0\text{ V}, f = 100\text{ kHz}, T_c = 25^\circ\text{C}$                                  |            |

**MOSFET Dynamic Characteristics per switch @  $T_J = 25^\circ\text{C}$**  (unless otherwise specified)

| Symbols   | Parameters                   | Min. | Typ.  | Max. | Unit | Test Conditions   | Notes                               |
|-----------|------------------------------|------|-------|------|------|---|-------------------------------------|
| $C_{iss}$ | Input Capacitance            |      | 29.10 |      | nF   | $V_{GS} = 0\text{ V}$<br>$V_{DS} = 900\text{ V}$<br>$f = 100\text{ kHz}$  |                                     |
| $C_{oss}$ | Output Capacitance           |      | 1.08  |      | nF   |   |                                     |
| $C_{rss}$ | Reverse Transfer Capacitance |      | 0.08  |      | nF   |   |                                     |
| $E_{on}$  | Turn-On Switching Energy     |      | 9.5   |      | mJ   | $V_{GS} = -8\text{ V to } +20\text{ V}$<br>$V_{DS} = 900\text{ V}$<br>$I_{DS} = 450\text{ A}$<br>$R_{Gon} = R_{Goff} = 1.0\ \Omega$ | Tested in half-bridge configuration |
| $E_{off}$ | Turn-Off Switching Energy    |      | 9.1   |      | mJ   |   |                                     |
| $t_r$     | Rise Time                    |      | 28.9  |      | ns   |   |                                     |
| $t_f$     | Fall Time                    |      | 35.7  |      | ns   |   |                                     |
| $Q_G$     | Total Gate Charge            |      | 1207  |      | nC   | $V_{GS} = 0\text{ to } 18\text{ V}$<br>$V_{DS} = 900\text{ V}$<br>$I_{DS} = 240\text{ A}$   |                                     |
| $Q_{GD}$  | Gate-Drain Charge            |      | 525   |      | nC   |   |                                     |
| $Q_{GS}$  | Gate-Source Charge           |      | 186   |      | nC   |   |                                     |

**Body Diode Characteristics per switch @  $T_J = 25^\circ\text{C}$**  (unless otherwise specified)

| Symbols  | Parameters                | Min. | Typ. | Max. | Unit | Test Conditions  | Notes |
|----------|---------------------------|------|------|------|------|--|-------|
| $I_{SD}$ | Pulsed body diode current |      |      | 720  | A    | $V_{GS} = 0\text{ V}$  | 1.    |
| $V_{SD}$ | Diode Forward Voltage     |      | 4.65 |      | V    | $V_{GS} = 0\text{ V}, I_{SD} = 425\text{ A}, T_J = 25^\circ\text{C}$ |       |

1. Use of body diode is recommended in pulse mode only

**Thermal Characteristics**

| Symbols  | Parameters                          | Min. | Typ. | Max. | Unit               | Test Conditions | Notes      |
|----------|-------------------------------------|------|------|------|--------------------|-----------------|------------|
| $R_{th}$ | Thermal Resistance Junction-to-Case |      | 0.10 | 0.12 | $^\circ\text{C/W}$ | JESD51-14       | Per Switch |



## Temperature Sensor Characteristics

| Symbols   | Parameters              | Min. | Typ. | Max. | Unit  | Test Conditions | Notes |
|-----------|-------------------------|------|------|------|-------|-----------------|-------|
| $R_{RTD}$ | Rated Resistance of RTD |      | 1k   |      | ohm   |                 | 2.    |
|           | Tolerance of Resistance |      | 0.12 |      | %     |                 |       |
|           | Accuracy                |      | 0.3  |      | °C    |                 |       |
|           | Measuring Current       | 100  |      | 300  | μA    |                 |       |
| TCR       | Temperature Coefficient |      | 3850 |      | ppm/K |                 |       |
|           | Operating Temperature   | -70  |      | +500 | °C    |                 |       |
|           | Insulation Resistance   |      | 100  |      | MOhm  | 20°C            |       |

2. RTD is mounted directly over center-most die allowing direct reading of  $T_j$

## Module packaging data

| Symbols    | Parameters                 | Min. | Typ.  | Max.       | Unit | Test Conditions              | Notes |
|------------|----------------------------|------|-------|------------|------|------------------------------|-------|
| $V_{Iso}$  | Case Isolation Voltage     | 4    |       |            | kV   | AC 50 Hz, 1 min, 25°C        |       |
| CTI        | Comparative Tracking Index |      | 600   |            |      |                              |       |
| $M_s$      | Mounting Torque            |      |       | 5.0<br>4.0 | N-m  | Power Terminals<br>Baseplate |       |
| $L_{D1S1}$ | Loop Inductance            |      | 1     |            | nH   |                              |       |
| $L_{D2S2}$ | Loop Inductance            |      | 1     |            | nH   |                              |       |
|            | Module Mass                |      | 0.12  |            | Kg   |                              |       |
|            | Clearance Distance         |      | 9     |            | mm   | D1 to D2                     |       |
|            |                            |      | 4     |            | mm   | D1 to S1                     |       |
|            |                            |      | 23    |            | mm   | Pins 1, 2 to S1              |       |
|            |                            |      | 25    |            | mm   | Pins 9, 10 to S1             |       |
|            |                            |      | 9     |            | mm   | D1, S2 to Baseplate          |       |
|            |                            |      | 12    |            | mm   | Pins 7, 8 to Baseplate       |       |
|            | Creepage Distance          |      | 11    |            | mm   | D1 to D2                     |       |
|            |                            |      | 6     |            | mm   | D1 to S1                     |       |
|            |                            |      | 28    |            | mm   | Pins 1, 2 to S1              |       |
|            |                            |      | 30    |            | mm   | Pins 9, 10 to S1             |       |
|            |                            |      | 12    |            | mm   | D1, S2 to Baseplate          |       |
|            |                            |      | 17    |            | mm   | Pins 7, 8 to Baseplate       |       |
| $M_{BP}$   | Base Plate Material        |      | AlSiC |            |      |                              |       |



Typical performance: **GE17042CCA3**

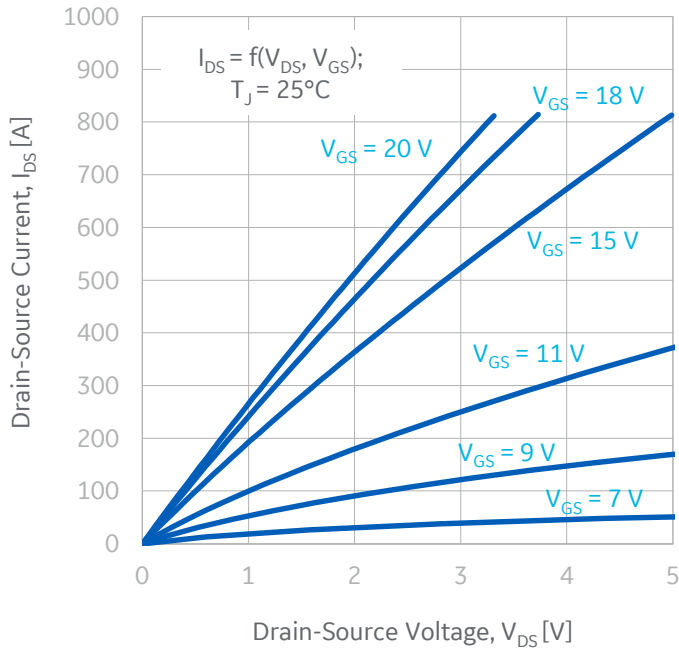

**Figure 1:** Output Characteristics (25°C)

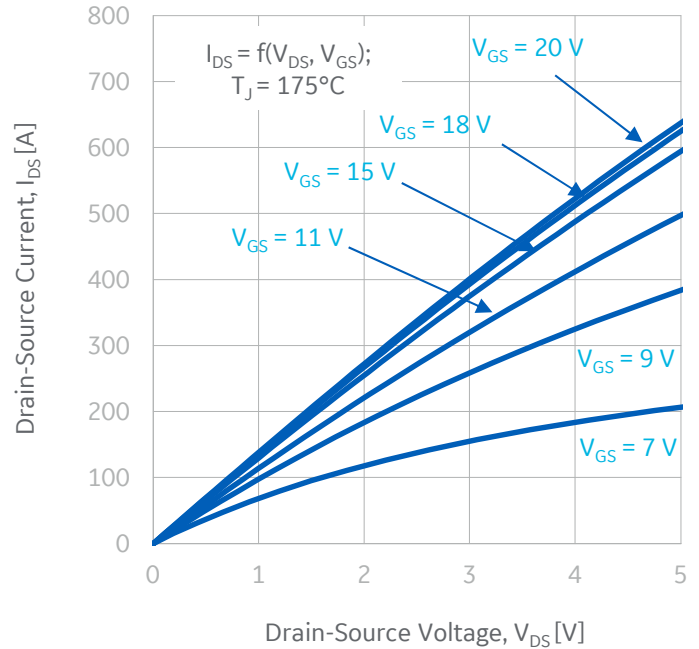

**Figure 2:** Output Characteristics (175°C)

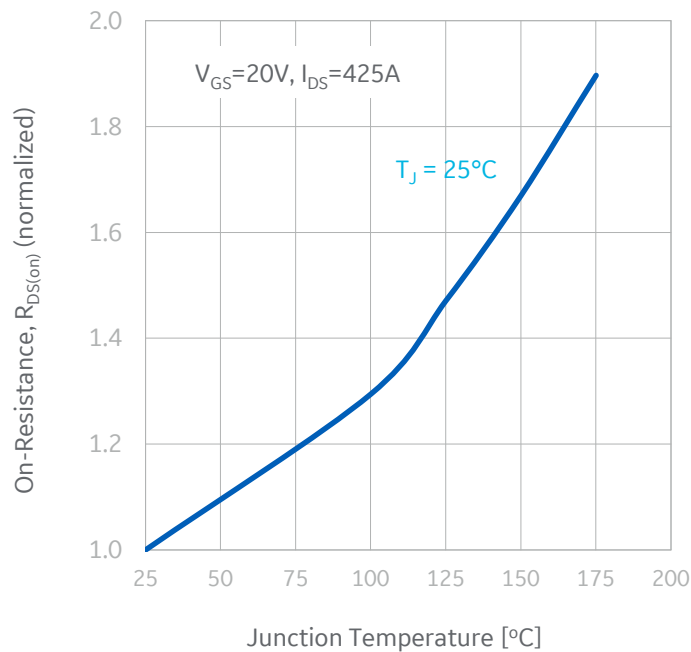

**Figure 3:** Normalized On-state Resistance vs. Temperature

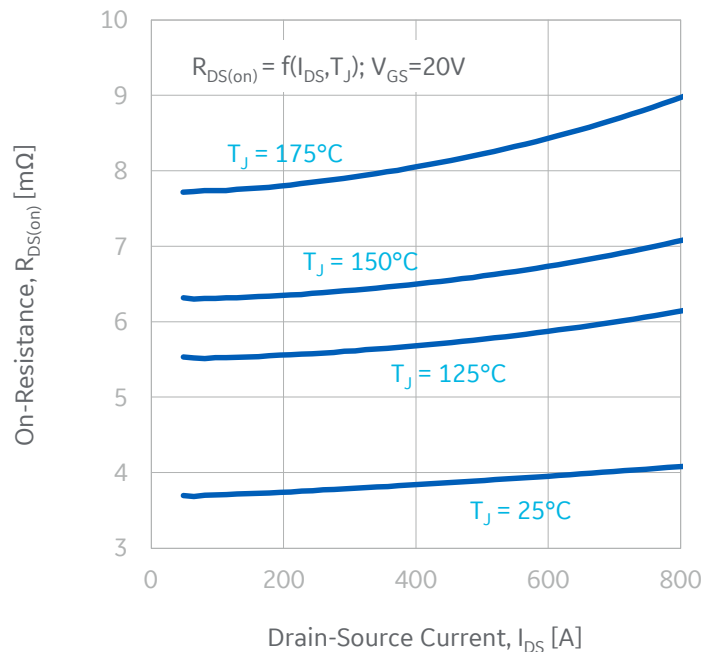

**Figure 4:** Module Drain-Source On-state Resistance



Typical performance: **GE17042CCA3**

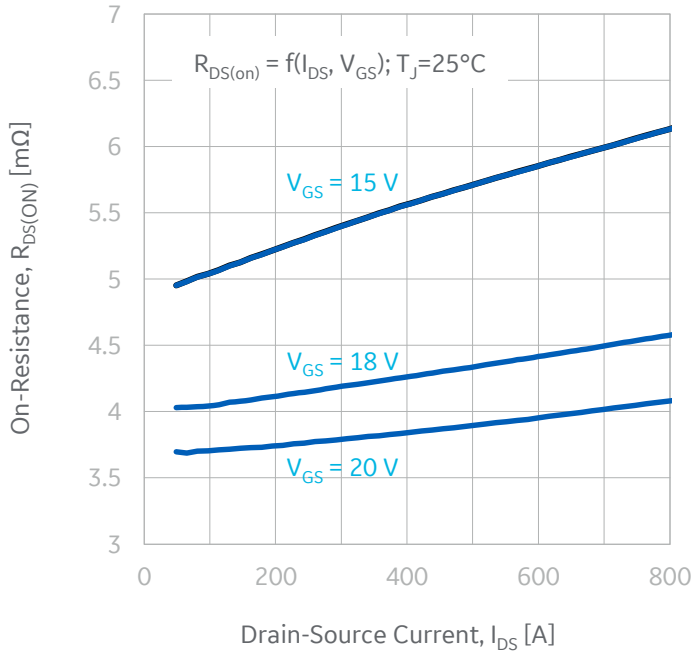

**Figure 5:** Module Drain-Source On-state Resistance

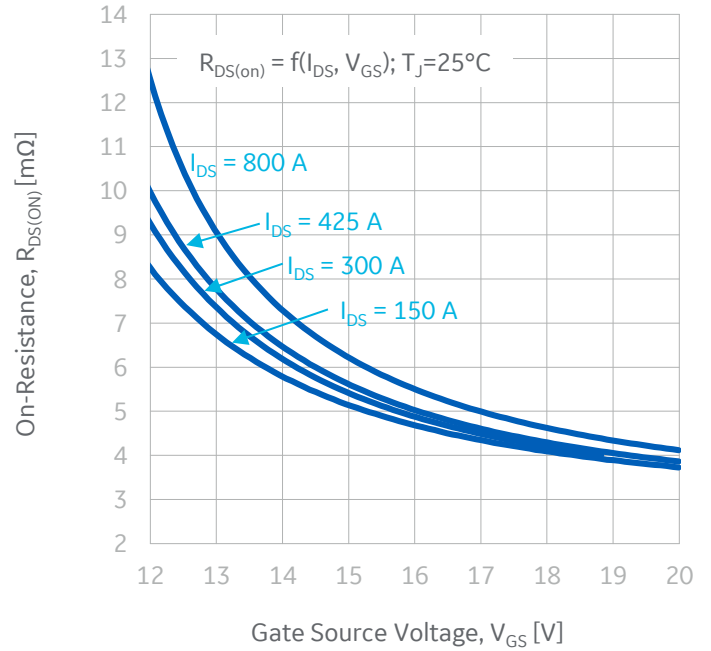

**Figure 6:** Drain-Source On-state Resistance vs. Gate Voltage

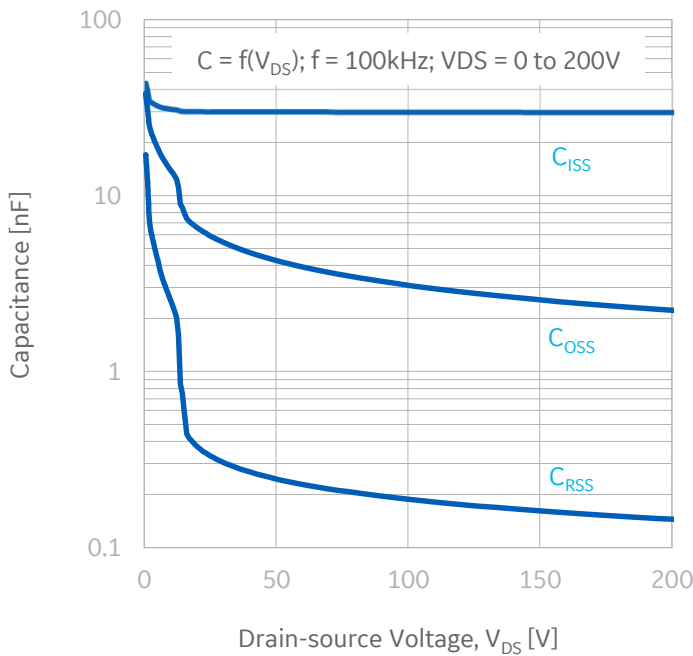

**Figure 7:** Junction Capacitances to 200 V

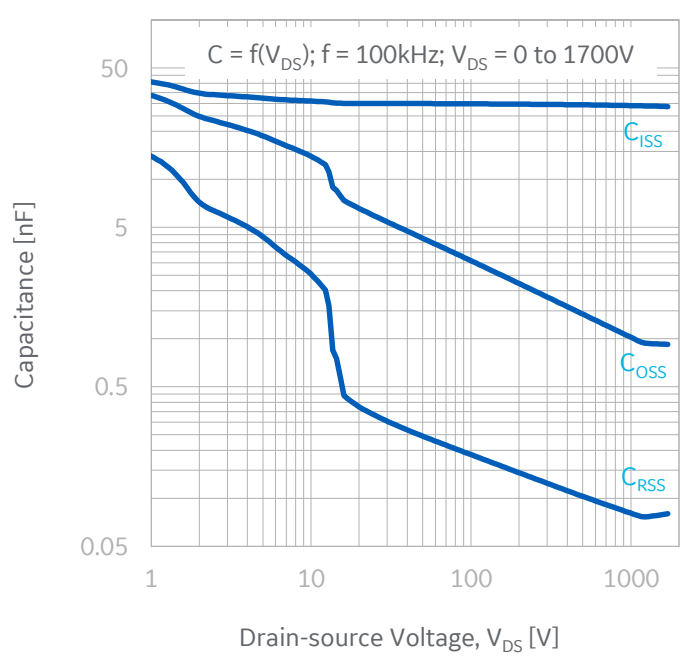

**Figure 8:** Junction Capacitances to 1700 V



Typical performance: **GE17042CCA3**

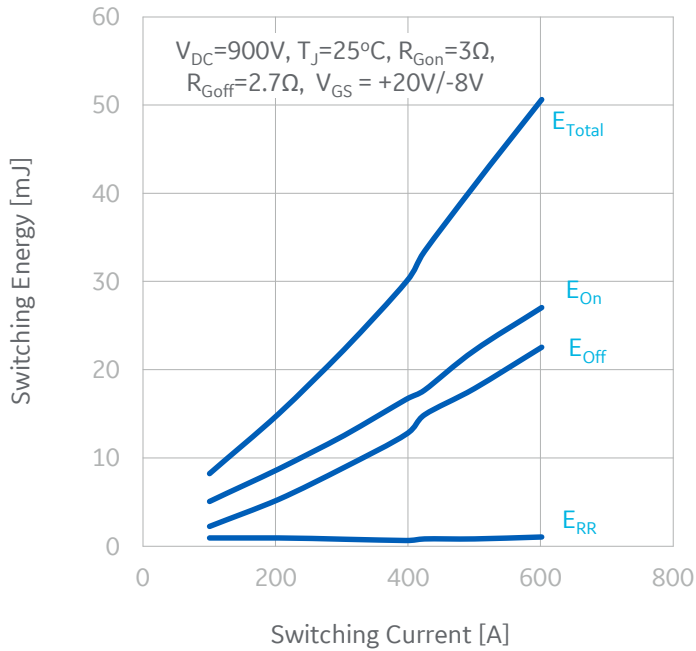

**Figure 9:** Switching Energy vs. Drain Current (900 V)

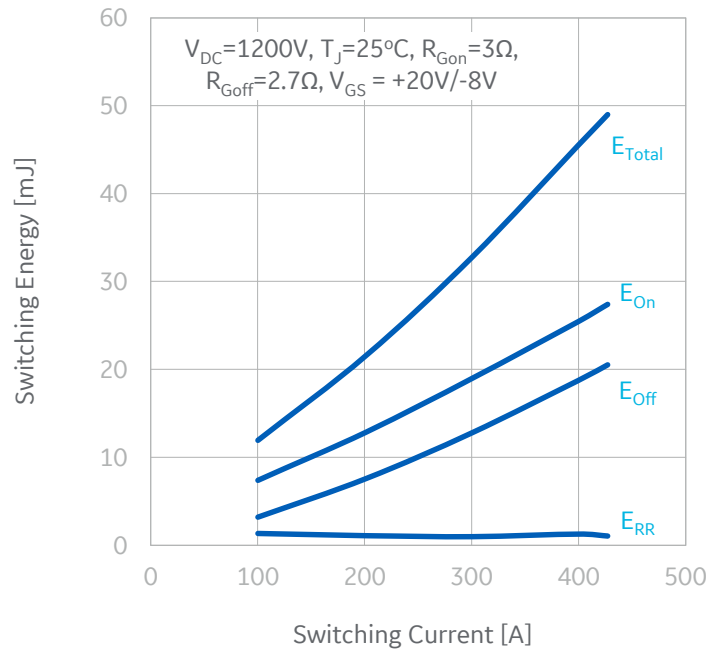

**Figure 10:** Switching Energy vs. Drain Current (1200 V)

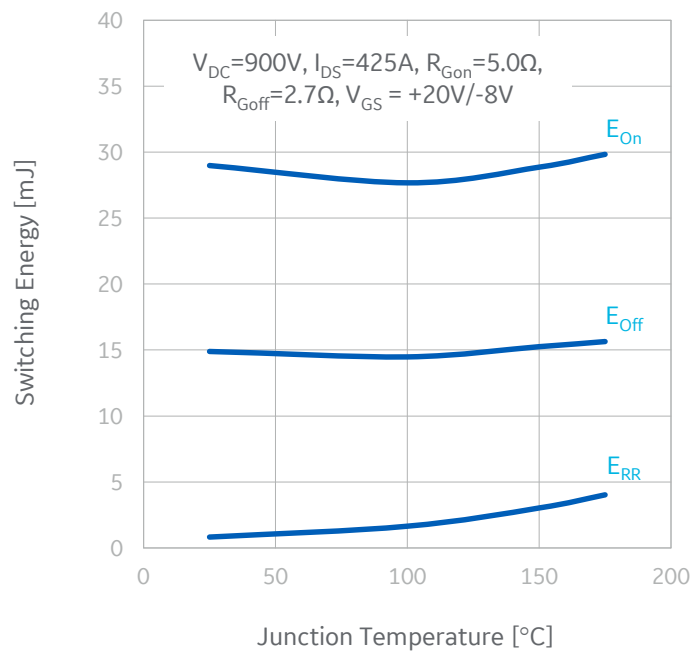

**Figure 11:** Switching Energy vs. Junction Temperature

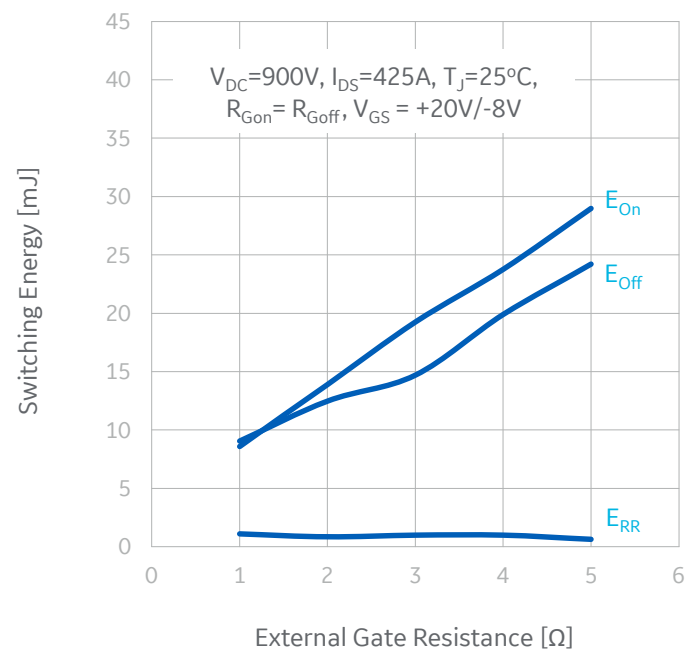

**Figure 12:** Switching Energy vs. Gate Resistance



Typical performance: GE17042CCA3

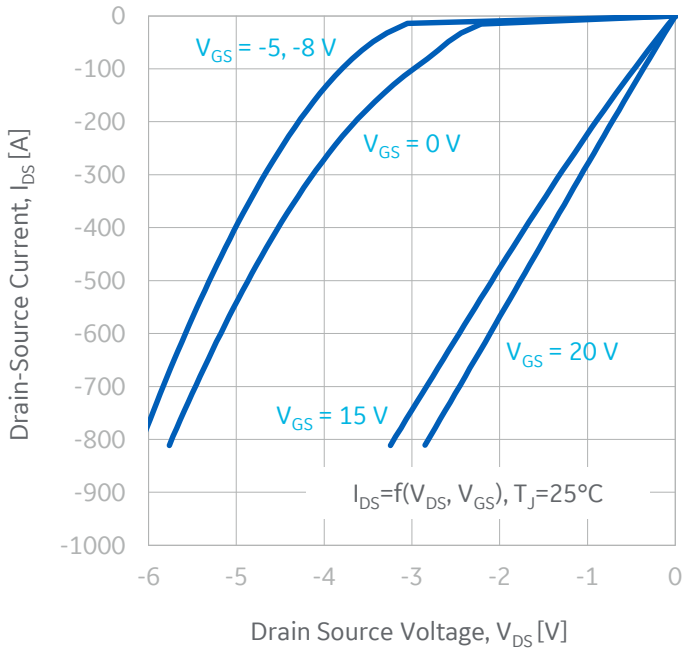

Figure 13: 3<sup>rd</sup> Quadrant Characteristics (25°C)

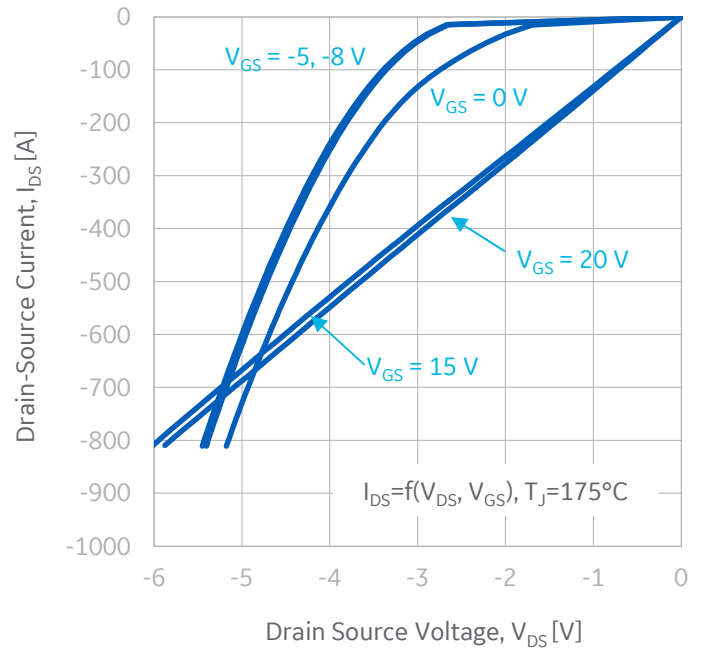

Figure 14: 3<sup>rd</sup> Quadrant Characteristics (175°C)

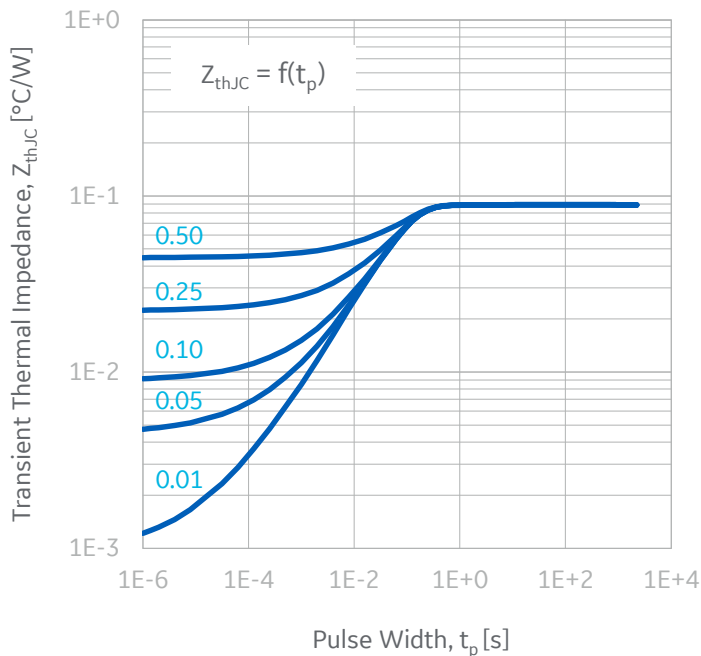

Figure 15: Transient Thermal Impedance

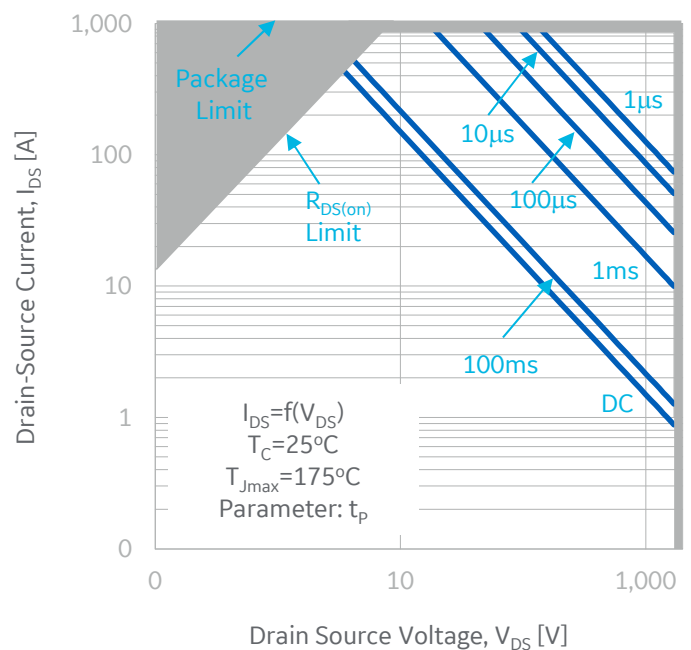
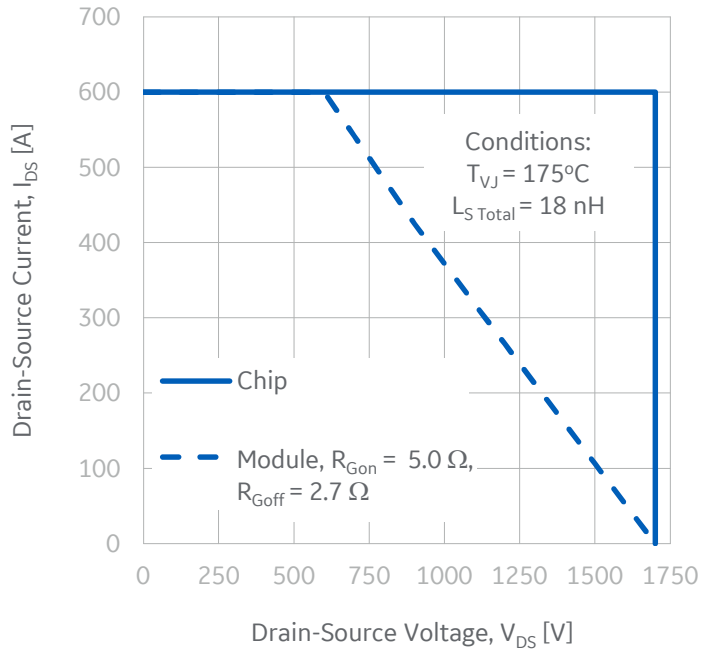

Figure 16: Forward-Bias Safe Operating Area



Typical performance: **GE17042CCA3**



**Figure 17:** Reverse-Bias Safe Operating Area

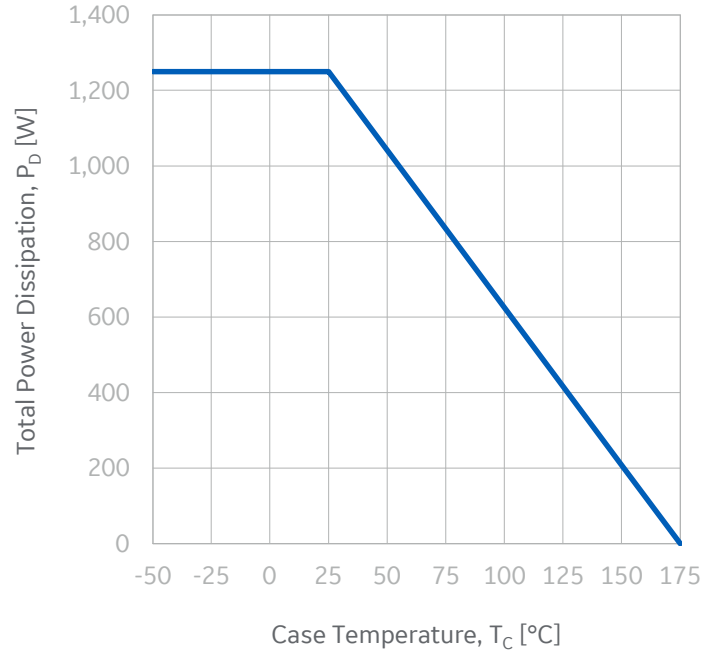
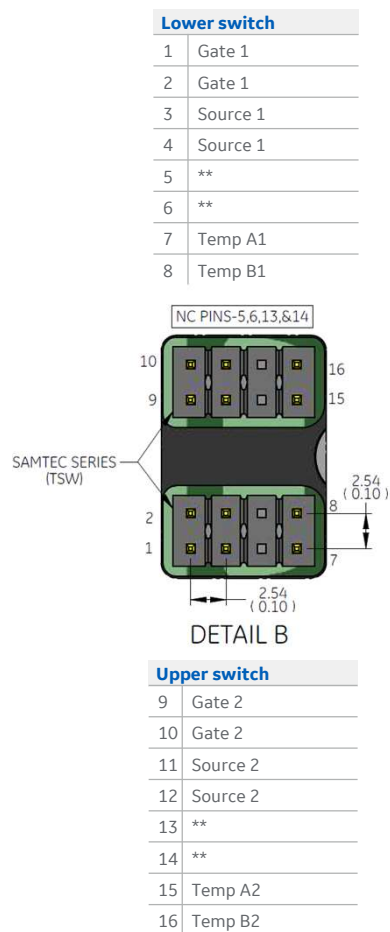

**Figure 18:** Maximum Power Dissipation vs. Case Temperature





## Electrical interface outline drawing



## Module dimensions (millimeters)

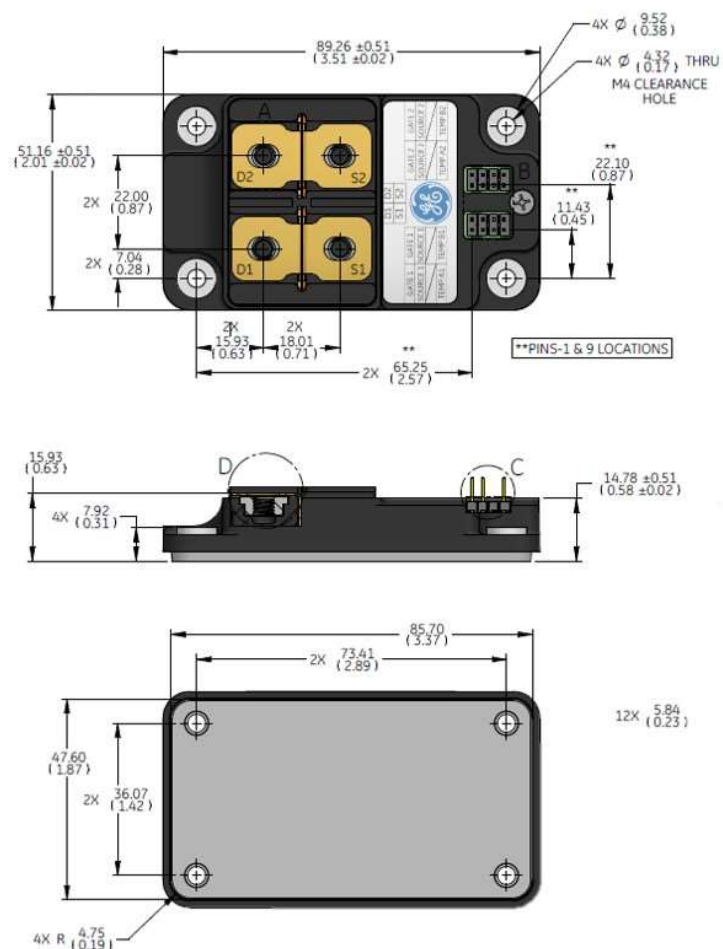

### Disclaimer

The data presented in this document are for informational purposes only and shall in no event be regarded as a guarantee of conditions or characteristics. Any warranty or license for this product shall be specified and governed by the terms of a separate purchase agreement. General Electric Company does not assume any liability arising out of the application or use of this product; neither does it convey any license under its patent rights, nor the rights of others.

General Electric Company reserves the right to make changes in specifications and features shown herein to improve reliability, function, or design, or discontinue this product, at any time without notice or obligation. Contact your GE representative for the most current information.

### Warning

This product is not authorized for use (1) in life support systems or (2) for applications implanted into the human body, without the express written approval of General Electric Company.

Questions or need help designing in GE SiC Power modules? Please contact:

[SiC.Products@ge.com](mailto:SiC.Products@ge.com)

GE Aerospace  
2705 Gateway Dr.  
Pompano Beach, FL 33069  
(954) 984-2400

### Document revisions

Rev 1.3 - Public Release - October 2022